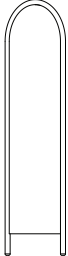
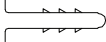
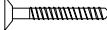

ARC FULL LENGTH MIRROR

CITTÀ

Installation Instructions

Arc Mirror	Wall Plugs x2	Screws x 2
		

We recommend using a qualified builder to install this product. Where possible it is recommend that the mirror is fixed into a wall stud.

1.

Using a pencil, mark on the wall the top centre position of the mirror's intended location. From this mark; measure and mark **40cm** down.

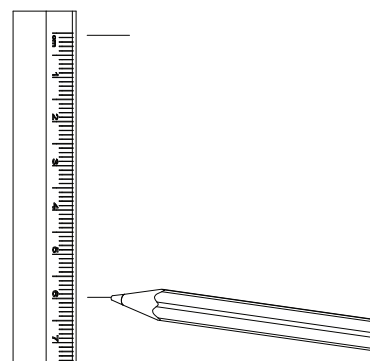

2.

Mark the centre line of where you want the mirror to be placed on the wall. Then measure and mark the exact distance from the centre line out to both keyhole fittings on each side of the frame, this will provide you with the two fixing points for the screws. Make sure to double check the overall distance between the two screw hole marks is exactly the same as the distance between the two keyhole fixings on the back of the mirror.

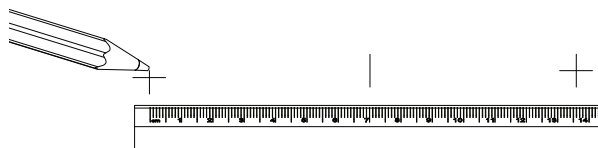

Hint to make sure your mirror hangs perfectly straight; you can use a level or a level phone app to make sure the two screw hole marks are horizontal.*

If you are fixing directly into a stud, please go to step 5.

ARC FULL LENGTH MIRROR

CITTÀ

Installation Instructions

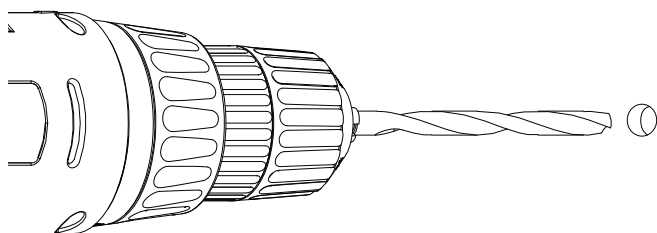

3.

Using a drill, drill two holes into the two screw hole marks on the wall.

4.

Gently hammer the two provided expansion anchors into the holes until they sit flush with the wall.

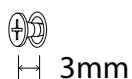
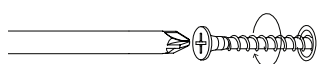
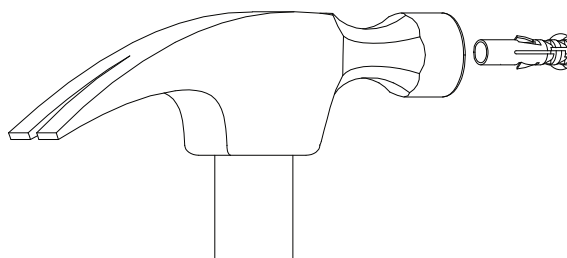

5.

Carefully screw the screws into the anchor holes until the ends of the screw head sits **3mm** off the wall. By doing this it will allow the mirror to fit snug and secure onto the mounting screws.

6.

Using the keyhole bracket at the back of the mirror, locate the mirror onto the mounting screws and carefully but firmly slide the mirror down to lock in place.

Hint you may need to re-adjust the mounting screws until the mirror is snugly secured to the wall.*

