

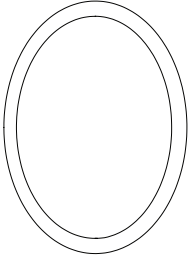

ARC ROUND HOOK

Installation Instructions

CITTÀ

Arc Round Mirror	Wall Bracket	Screws and Wall Plugs
		

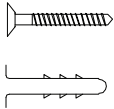
We recommend using a qualified builder to install this product. Where possible it is recommend that the mirror is fixed into a wall stud.

1.

Using a pencil, mark on the wall the top centre position of the mirror's intended location. From this mark; measure and mark 20cm down. This will provide you with bottom position of the wall bracket.

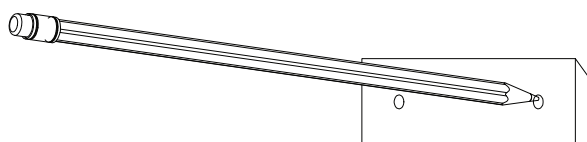
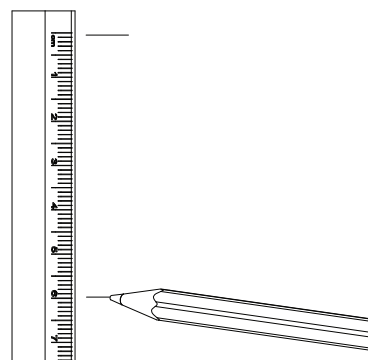

2.

Locate the wall bracket onto the pencil mark from step 1 and mark where the two screw hole locations are.

hint to make sure your mirror hangs perfectly straight; you can use a level or a level phone app to make sure the two screw hole marks are horizontal.*

If you are fixing directly into a stud, please go to step 5.

ARC ROUND HOOK

Installation Instructions

CITTÀ

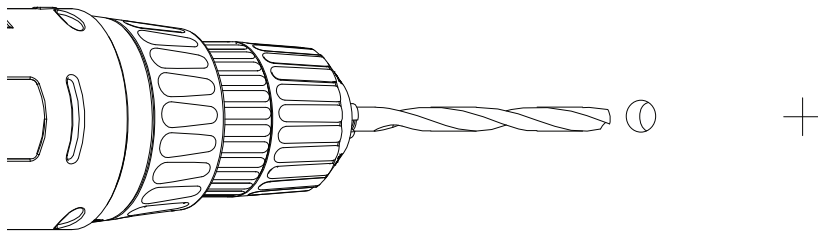

3.

Using a drill, drill two holes into the two screw hole marks on the wall.

4.

Gently hammer the two provided wall plugs into the holes until they sit flush with the wall.

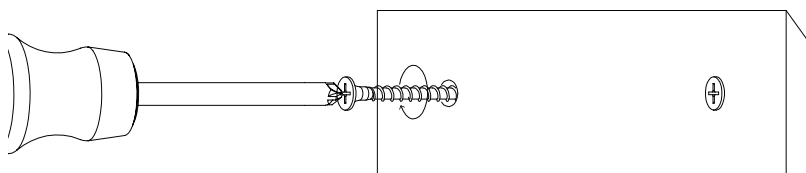
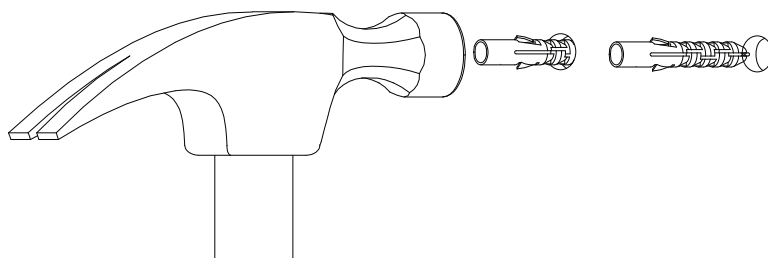

5.

Using a screwdriver, screw the wall bracket into the anchor holes.

6.

Carefully locate the mirror onto the wall bracket.

